

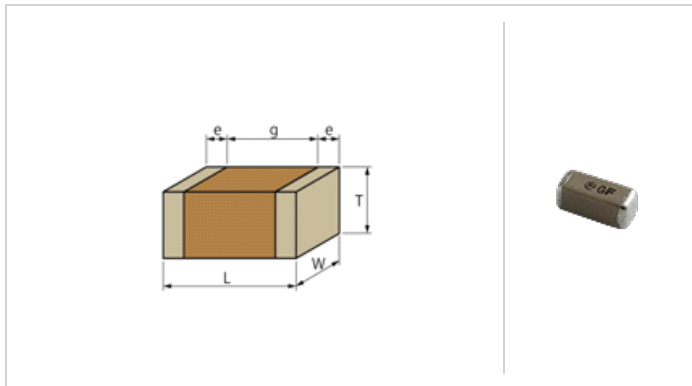

Deadline for last orders: 31 Mar 2019 Date of discontinuation: 30 Sep 2019

< List of part numbers with package codes >
GA342D1XGD180JY02L , GA342D1XGD180JY02K

Shape



L size	4.5 ±0.3mm
W size	2.0 ±0.2mm
T size	2.0 ±0.2mm
External terminal width e	0.3mm min.
Distance between external terminals g	2.5mm min.
Size code in inch(mm)	1808 (4520M)

Notes

Please use replacements or Recommended.

References

Packaging	Specifications	Minimum quantity
L	φ180mm Embossed taping	2000
K	φ330mm Embossed taping	8000

Mass (typ.)	
1 piece	72mg
φ180mm Reel	221g

Specifications

Capacitance	18pF ±5%
Rated voltage	250Vac
Temperature characteristics (complied standard)	SL(JIS)
Temperature coefficient	+350 to -1000ppm/°C
Temperature range of temperature characteristics	20 to 85°C
Operating temperature range	-55 to 125°C

Attention

- 1.This datasheet is downloaded from the website of Murata Manufacturing Co., Ltd. Therefore, it's specifications are subject to change or our products in it may be discontinued without advance notice. Please check with our sales representatives or product engineers before ordering.
- 2.This datasheet has only typical specifications because there is no space for detailed specifications. Therefore, please review our product specifications or consult the approval sheet for product specifications before ordering.