

### Chopper IGBT NX-Series Module 150 Amperes/1200 Volts

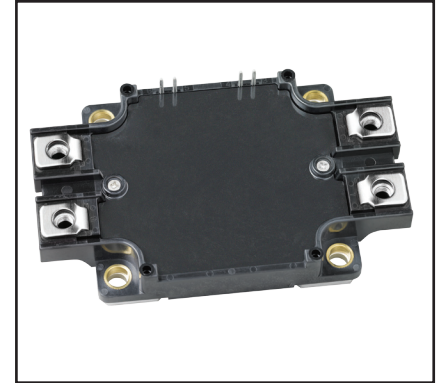
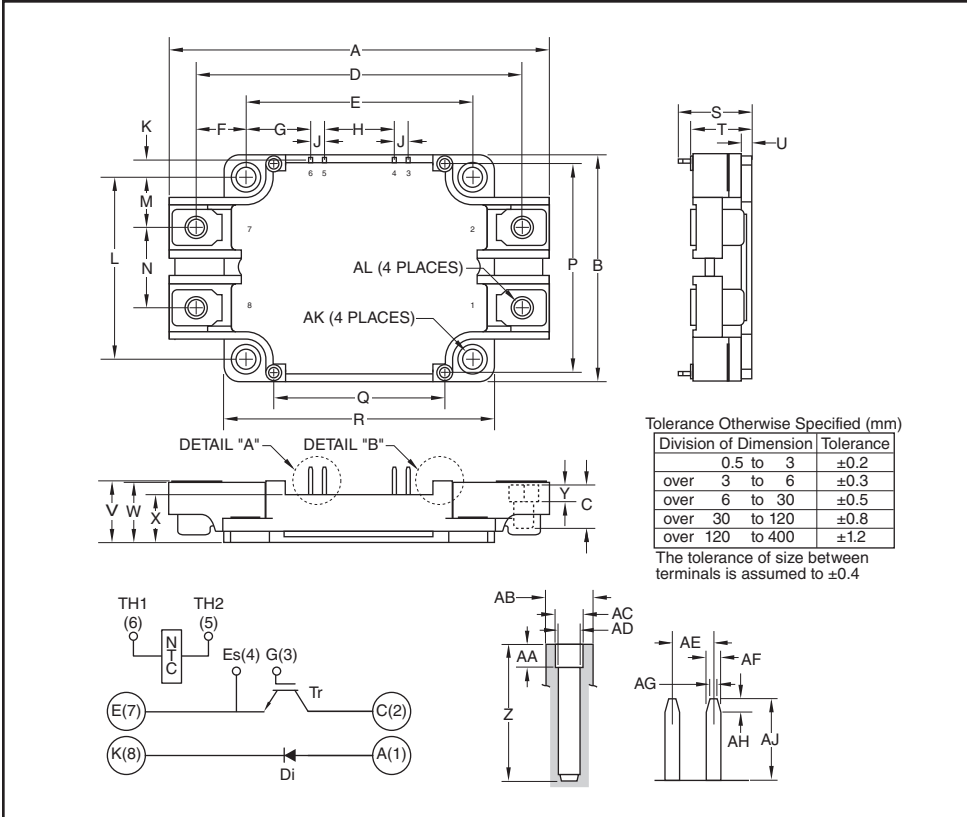

#### Description:

Powerex IGBT Modules are designed for use in switching applications. Each module consists of one IGBT Transistor and one super-fast recovery diode. All components and interconnects are isolated from the heat sinking baseplate, offering simplified system assembly and thermal management.

#### Features:

- Low Drive Power
- Low  $V_{CE(sat)}$
- Discrete Super-Fast Recovery Clamp Diode
- RoHS Compliant
- Isolated Copper Baseplate for Easy Heat Sinking

#### Applications:

- DC/DC Converter
- DC Motor Control
- Brake Circuit

#### Ordering Information:

Example: Select the complete module number you desire from the table below -i.e. CM150EXS-24S is a 1200V ( $V_{CES}$ ), 150 Ampere Chopper IGBT Power Module.

#### Outline Drawing and Circuit Diagram

Dimensions	Inches	Millimeters
A	4.09	104.0
B	2.44	62.0
C	0.47	11.9
D	3.5	89.0
E	2.44	62.0
F	0.53	13.5
G	0.69	17.66
H	0.75	19.05
J	0.14	3.8
K	0.16	4.2
L	1.97	50.0
M	0.55	14.0
N	0.87	22.0
P	2.26	57.5
Q	1.83	46.5
R	2.9	73.71
S	0.8	20.5
T	0.67	17.0

Dimensions	Inches	Millimeters
U	0.27	7.0
V	0.67	17.0
W	0.64	16.4
X	0.51	13.1
Y	0.17	4.4
Z	0.49	12.5
AA	0.12	3.0
AB	0.17 Dia.	4.3 Dia.
AC	0.102 Dia.	2.6 Dia.
AD	0.088 Dia.	2.25 Dia.
AE	0.15	3.81
AF	0.045	1.15
AG	0.025	0.65
AH	0.05	1.2
AJ	0.29	7.4
AK	0.21 Dia.	5.5 Dia.
AL	M5	M5

Type	Current Rating Amperes	$V_{CES}$ Volts (x 50)
CM	150	24

**CM150EXS-24S**  
**Chopper IGBT NX-Series Module**  
 150 Amperes/1200 Volts

**Absolute Maximum Ratings,  $T_j = 25^\circ\text{C}$  unless otherwise specified**

Characteristics	Symbol	Rating	Units
Collector-Emitter Voltage ( $V_{GE} = 0\text{V}$ )	$V_{CES}$	1200	Volts
Gate-Emitter Voltage ( $V_{CE} = 0\text{V}$ )	$V_{GES}$	$\pm 20$	Volts
Collector Current (DC, $T_C = 120^\circ\text{C}$ )* <sup>2</sup>	$I_C$	150	Amperes
Collector Current (Pulse, Repetitive)* <sup>3</sup>	$I_{CRM}$	300	Amperes
Total Power Dissipation ( $T_C = 25^\circ\text{C}$ )* <sup>2,4</sup>	$P_{tot}$	1150	Watts
Repetitive Peak Reverse Voltage (Clamp Diode Part, $V_{GE} = 0\text{V}$ )	$V_{RRM}$	1200	Volts
Forward Current (Clamp Diode Part, $T_C = 25^\circ\text{C}$ )* <sup>2,4</sup>	$I_F^{*1}$	150	Amperes
Forward Current (Clamp Diode Part, Pulse, Repetitive)* <sup>3</sup>	$I_{FRM}^{*1}$	300	Amperes
Maximum Junction Temperature	$T_{j(max)}$	+175	$^\circ\text{C}$
Operating Junction Temperature	$T_{j(op)}$	-40 to +150	$^\circ\text{C}$
Storage Temperature	$T_{stg}$	-40 to +125	$^\circ\text{C}$
Case Temperature	$T_C$	-40 to +125	$^\circ\text{C}$
Isolation Voltage (Terminals to Baseplate, $f = 60\text{Hz}$ , AC 1 minute)	$V_{ISO}$	2500	Volts

\*1 Represent ratings and characteristics of the anti-parallel, emitter-to-collector clamp diode.

\*2 Case temperature ( $T_C$ ) and heatsink temperature ( $T_s$ ) is measured on the surface (mounting side) of the baseplate and the heatsink side just under the chips. Refer to the figure to the right for chip location.

The heatsink thermal resistance should be measured just under the chips.

\*3 Pulse width and repetition rate should be such that device junction temperature ( $T_j$ ) does not exceed  $T_{j(max)}$  rating.

\*4 Junction temperature ( $T_j$ ) should not increase beyond maximum junction temperature ( $T_{j(max)}$ ) rating.

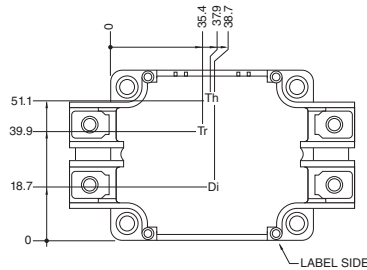

Each mark points to the center position of each chip.  
 Tr: IGBT Di: Clamp Diode Th: NTC Thermistor

**CM150EXS-24S**  
**Chopper IGBT NX-Series Module**  
 150 Amperes/1200 Volts

**Electrical Characteristics,  $T_j = 25^\circ\text{C}$  unless otherwise specified**

Characteristics	Symbol	Test Conditions	Min.	Typ.	Max.	Units
Collector-Emitter Cutoff Current	$I_{CES}$	$V_{CE} = V_{CES}, V_{GE} = 0V$	—	—	1	mA
Gate-Emitter Leakage Current	$I_{GES}$	$\pm V_{GE} = V_{GES}, V_{CE} = 0V$	—	—	0.5	$\mu\text{A}$
Gate-Emitter Threshold Voltage	$V_{GE(th)}$	$I_C = 15\text{mA}, V_{CE} = 10V$	5.4	6	6.6	Volts
Collector-Emitter Saturation Voltage (Terminal)	$V_{CE(sat)}$	$I_C = 150\text{A}, V_{GE} = 15V, T_j = 25^\circ\text{C}^6$	—	1.80	2.25	Volts
		$I_C = 150\text{A}, V_{GE} = 15V, T_j = 125^\circ\text{C}^6$	—	2.00	—	Volts
		$I_C = 150\text{A}, V_{GE} = 15V, T_j = 150^\circ\text{C}^6$	—	2.05	—	Volts
Collector-Emitter Saturation Voltage (Chip)	$V_{CE(sat)}$	$I_C = 150\text{A}, V_{GE} = 15V, T_j = 25^\circ\text{C}^6$	—	1.70	2.15	Volts
		$I_C = 150\text{A}, V_{GE} = 15V, T_j = 125^\circ\text{C}^6$	—	1.90	—	Volts
		$I_C = 150\text{A}, V_{GE} = 15V, T_j = 150^\circ\text{C}^6$	—	1.95	—	Volts
Input Capacitance	$C_{ies}$		—	—	15	nF
Output Capacitance	$C_{oes}$	$V_{CE} = 10V, V_{GE} = 0V$	—	—	3.0	nF
Reverse Transfer Capacitance	$C_{res}$		—	—	0.25	nF
Gate Charge	$Q_G$	$V_{CC} = 600V, I_C = 150A, V_{GE} = 15V$	—	350	—	nC
Turn-on Delay Time	$t_{d(on)}$		—	—	800	ns
Rise Time	$t_r$	$V_{CC} = 600V, I_C = 150A, V_{GE} = \pm 15V,$	—	—	200	ns
Turn-off Delay Time	$t_{d(off)}$	$R_G = 0\Omega, \text{ Inductive Load}$	—	—	600	ns
Fall Time	$t_f$		—	—	300	ns
Repetitive Peak Reverse Current	$I_{RRM}$	$V_R = V_{RRM}$	—	—	1	mA
Forward Voltage Drop	$V_F^{*1}$	$I_F = 150A, V_{GE} = 0V, T_j = 25^\circ\text{C}^6$	—	1.80	2.25	Volts
Clamp Di Part (Terminal)		$I_F = 150A, V_{GE} = 0V, T_j = 125^\circ\text{C}^6$	—	1.80	—	Volts
		$I_F = 150A, V_{GE} = 0V, T_j = 150^\circ\text{C}^6$	—	1.80	—	Volts
Forward Voltage Drop	$V_F^{*1}$	$I_F = 150A, V_{GE} = 0V, T_j = 25^\circ\text{C}^6$	—	1.70	2.15	Volts
Clamp Di Part (Chip)		$I_F = 150A, V_{GE} = 0V, T_j = 125^\circ\text{C}^6$	—	1.70	—	Volts
		$I_F = 150A, V_{GE} = 0V, T_j = 150^\circ\text{C}^6$	—	1.70	—	Volts
Reverse Recovery Time	$t_{rr}^{*1}$	$V_{CC} = 600V, I_F = 150A, V_{GE} = \pm 15V$	—	—	300	ns
Reverse Recovery Charge	$Q_{rr}^{*1}$	$R_G = 0\Omega, \text{ Inductive Load, Clamp Di Part}$	—	8.0	—	$\mu\text{C}$
Turn-on Switching Energy per Pulse	$E_{on}$	$V_{CC} = 600V, I_C = I_F = 150A,$	—	24.2	—	mJ
Turn-off Switching Energy per Pulse	$E_{off}$	$V_{GE} = \pm 15V, R_G = 0\Omega, T_j = 150^\circ\text{C},$	—	16.0	—	mJ
Reverse Recovery Energy per Pulse	$E_{rr}^{*1}$	$\text{ Inductive Load, Clamp Di Part}$	—	12.2	—	mJ
Internal Lead Resistance	$R_{CC} + EE'$	Main Terminals-Chip, Per Switch, $T_C = 25^\circ\text{C}^2$	—	—	—	m $\Omega$
Internal Gate Resistance	$r_g$		—	13	—	$\Omega$

\*1 Represent ratings and characteristics of the anti-parallel, emitter-to-collector clamp diode.

\*2 Case temperature ( $T_C$ ) and heatsink temperature ( $T_s$ ) is measured on the surface (mounting side) of the baseplate and the heatsink side just under the chips. Refer to the figure to the right for chip location.

The heatsink thermal resistance should be measured just under the chips.

\*6 Pulse width and repetition rate should be such as to cause negligible temperature rise.

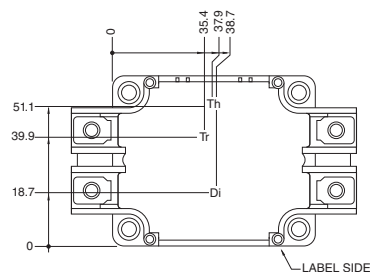

Each mark points to the center position of each chip.  
 Tr: IGBT Di: Clamp Diode Th: NTC Thermistor

**CM150EXS-24S**  
**Chopper IGBT NX-Series Module**  
 150 Amperes/1200 Volts

**Electrical Characteristics,  $T_j = 25^\circ\text{C}$  unless otherwise specified (continued)**

**NTC Thermistor Part**

Characteristics	Symbol	Test Conditions	Min.	Typ.	Max.	Units
Zero Power Resistance	$R_{25}$	$T_C = 25^\circ\text{C}^{*2}$	4.85	5.00	5.15	k $\Omega$
Deviation of Resistance	$\Delta R/R$	$T_C = 100^\circ\text{C}$ , $R_{100} = 493\Omega$	-7.3	—	+7.8	%
B Constant	$B_{(25/50)}$	Approximate by Equation <sup>*8</sup>	—	3375	—	K
Power Dissipation	$P_{25}$	$T_C = 25^\circ\text{C}^{*2}$	—	—	10	mW

**Thermal Resistance Characteristics**

Characteristics	Symbol	Test Conditions	Min.	Typ.	Max.	Units
Thermal Resistance, Junction to Case <sup>*2</sup>	$R_{th(j-c)Q}$	Per IGBT	—	—	0.13	K/W
Thermal Resistance, Junction to Case <sup>*2</sup>	$R_{th(j-c)D}$	Per Clamp Diode	—	—	0.23	K/W
Contact Thermal Resistance, Case to Heatsink <sup>*2</sup>	$R_{th(c-f)}$	Thermal Grease Applied (Per 1 Module) <sup>*7</sup>	—	25	—	K/kW

**Mechanical Characteristics**

Characteristics	Symbol	Test Conditions	Min.	Typ.	Max.	Units
Mounting Torque	$M_t$	Main Terminals, M5 Screw	22	27	31	in-lb
	$M_s$	Mounting to Heatsink, M5 Screw	22	27	31	in-lb
Creepage Distance	$d_s$	Terminal to Terminal	20	—	—	mm
		Terminal to Baseplate	17	—	—	mm
Clearance	$d_a$	Terminal to Terminal	12	—	—	mm
		Terminal to Baseplate	10	—	—	mm
Weight	$m$		—	210	—	Grams
Flatness of Baseplate	$e_c$	On Centerline X, Y <sup>*5</sup>	-100	—	+100	$\mu\text{m}$

**Recommended Operating Conditions,  $T_a = 25^\circ\text{C}$**

Characteristics	Symbol	Test Conditions	Min.	Typ.	Max.	Units
(DC) Supply Voltage	$V_{CC}$	Applied Across P-N	—	600	850	Volts
Gate-Emitter Drive Voltage	$V_{GE(on)}$	Applied Across G-E	13.5	15.0	16.5	Volts
External Gate Resistance	$R_G$		0	—	30	$\Omega$

<sup>\*2</sup> Case temperature ( $T_C$ ) and heatsink temperature ( $T_s$ ) is measured on the surface (mounting side) of the baseplate and the heatsink side just under the chips.

Refer to the figure to the right for chip location.

The heatsink thermal resistance should be measured just under the chips.

<sup>\*5</sup> Baseplate (mounting side) flatness measurement points (X, Y) are shown in the figure below.

<sup>\*7</sup> Typical value is measured by using thermally conductive grease of  $\lambda = 0.9 \text{ [W/(m} \cdot \text{K)]}$ .

<sup>\*8</sup>  $B_{(25/50)} = \ln\left(\frac{R_{25}}{R_{50}}\right) / \left(\frac{1}{T_{25}} - \frac{1}{T_{50}}\right)$

$R_{25}$ ; Resistance at Absolute Temperature  $T_{25}$  [K];  $T_{25} = 25 [^\circ\text{C}] + 273.15 = 298.15$  [K]

$R_{50}$ ; Resistance at Absolute Temperature  $T_{50}$  [K];  $T_{50} = 50 [^\circ\text{C}] + 273.15 = 323.15$  [K]

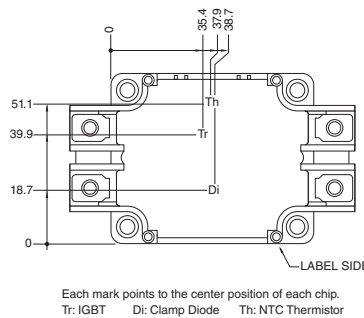
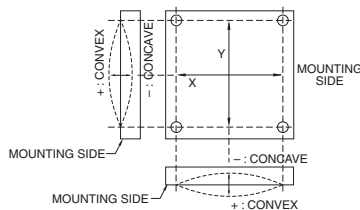

Each mark points to the center position of each chip.  
 Tr: IGBT Di: Clamp Diode Th: NTC Thermistor

**CM150EXS-24S**  
**Chopper IGBT NX-Series Module**  
 150 Amperes/1200 Volts

**OUTPUT CHARACTERISTICS**  
(CHIP - TYPICAL)

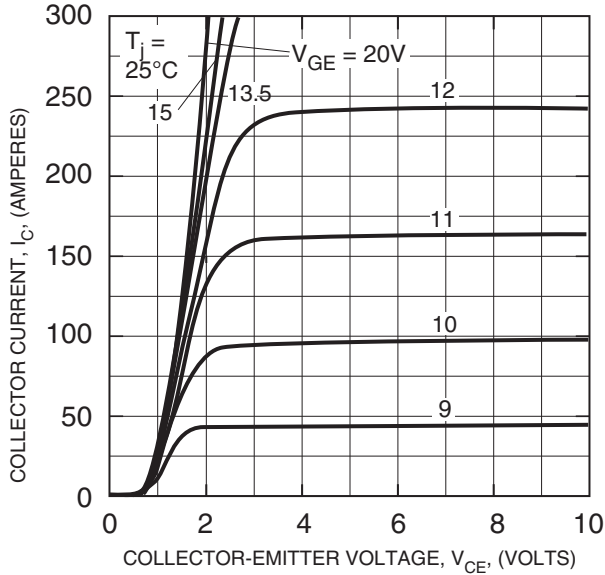

**COLLECTOR-EMITTER SATURATION VOLTAGE CHARACTERISTICS**  
(CHIP - TYPICAL)

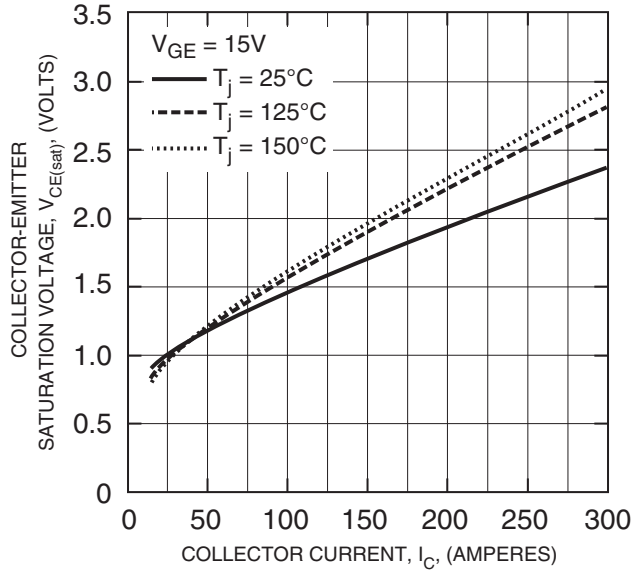

**COLLECTOR-EMITTER SATURATION VOLTAGE CHARACTERISTICS**  
(CHIP - TYPICAL)

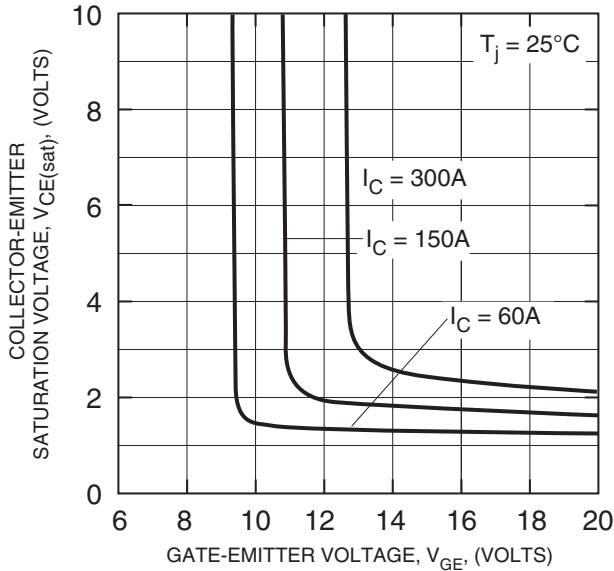

**FREE-WHEEL DIODE FORWARD CHARACTERISTICS**  
(CHIP - TYPICAL)

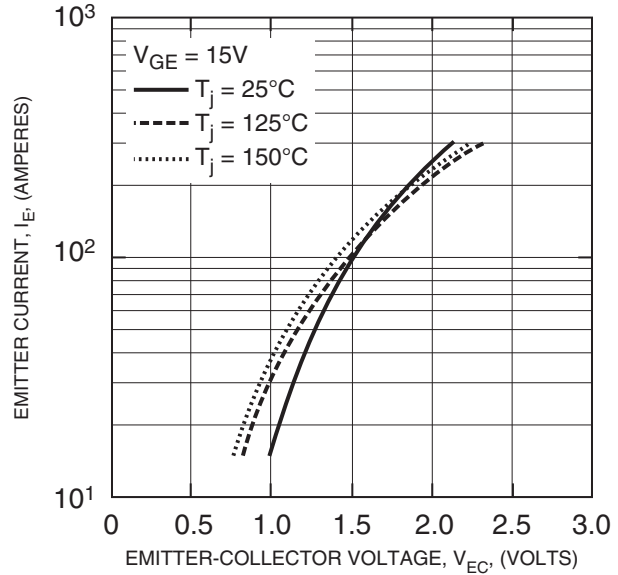

**CM150EXS-24S**  
**Chopper IGBT NX-Series Module**  
 150 Amperes/1200 Volts

**CAPACITANCE VS.  $V_{CE}$**   
 (TYPICAL)

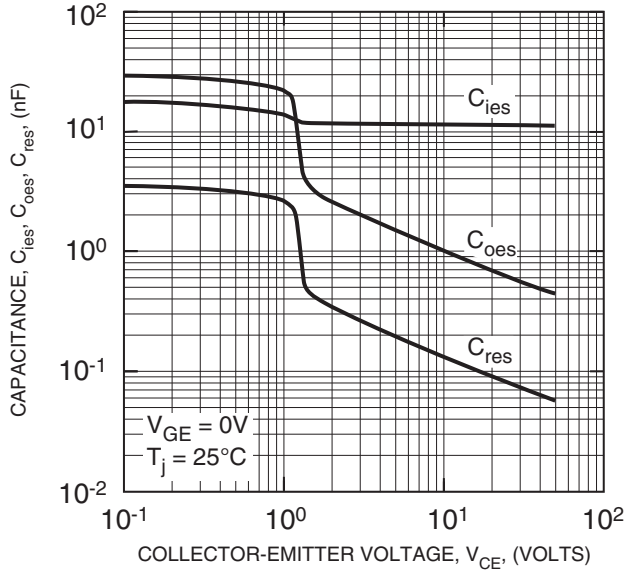

**HALF-BRIDGE SWITCHING CHARACTERISTICS**  
 (TYPICAL)

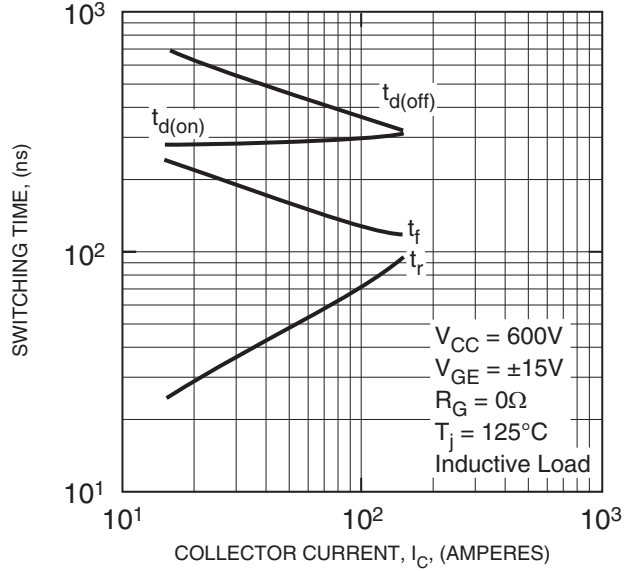

**HALF-BRIDGE SWITCHING CHARACTERISTICS**  
 (TYPICAL)

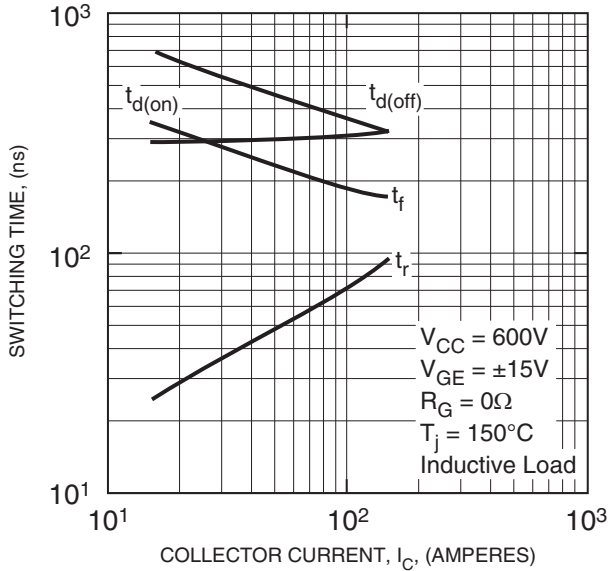

**SWITCHING TIME VS. GATE RESISTANCE**  
 (TYPICAL)

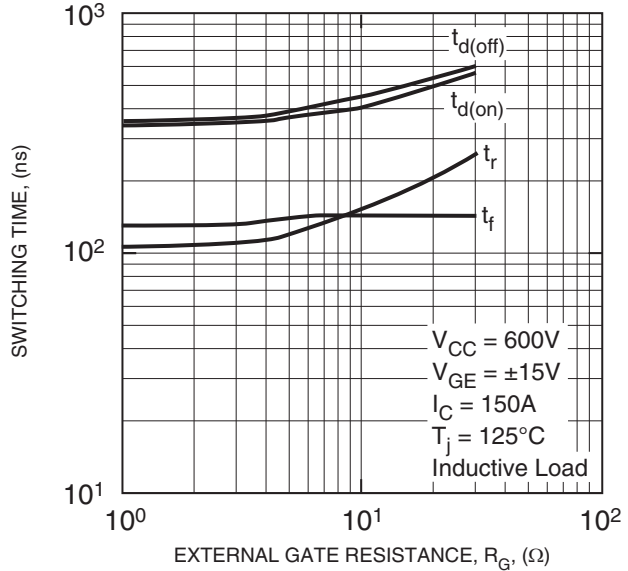

**CM150EXS-24S**  
**Chopper IGBT NX-Series Module**  
 150 Amperes/1200 Volts

**SWITCHING TIME VS. GATE RESISTANCE (TYPICAL)**

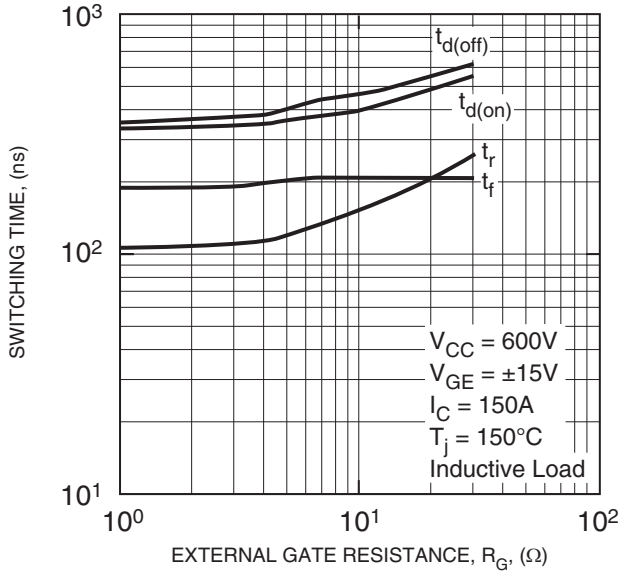

**REVERSE RECOVERY CHARACTERISTICS (TYPICAL)**

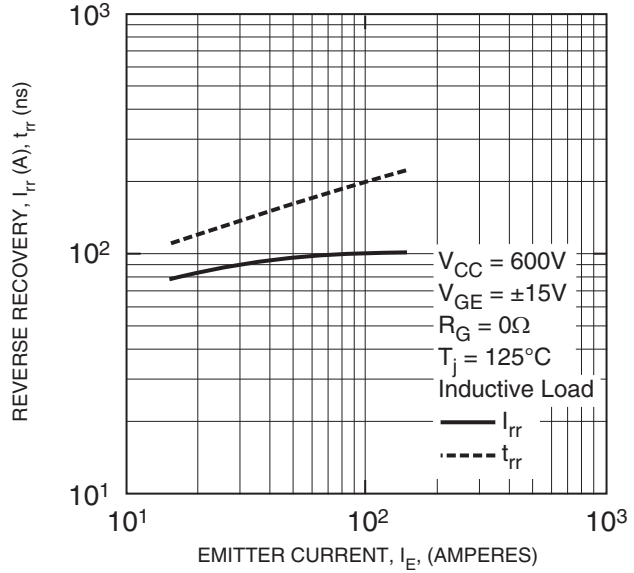

**REVERSE RECOVERY CHARACTERISTICS (TYPICAL)**

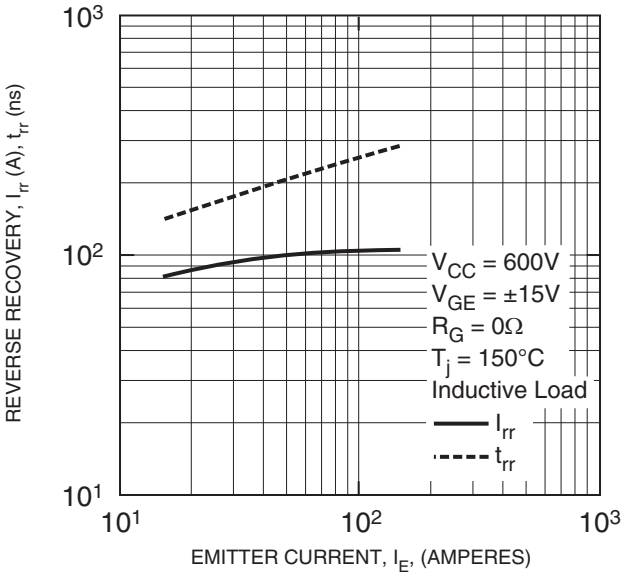

**GATE CHARGE VS.  $V_{GE}$**

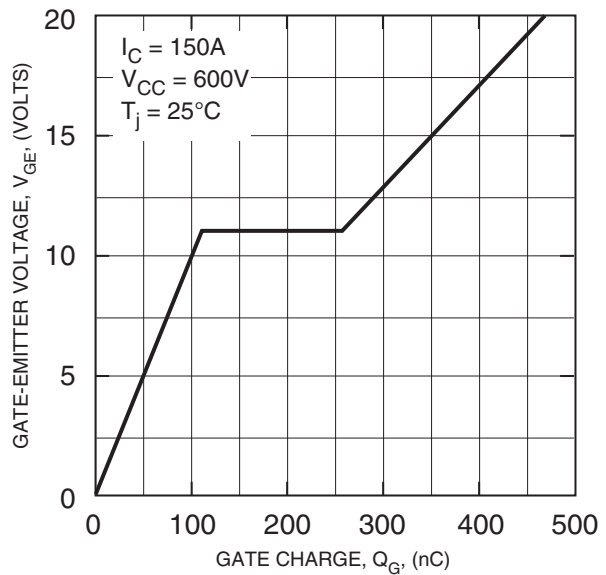

**CM150EXS-24S**  
**Chopper IGBT NX-Series Module**  
 150 Amperes/1200 Volts

**HALF-BRIDGE SWITCHING CHARACTERISTICS (TYPICAL)**

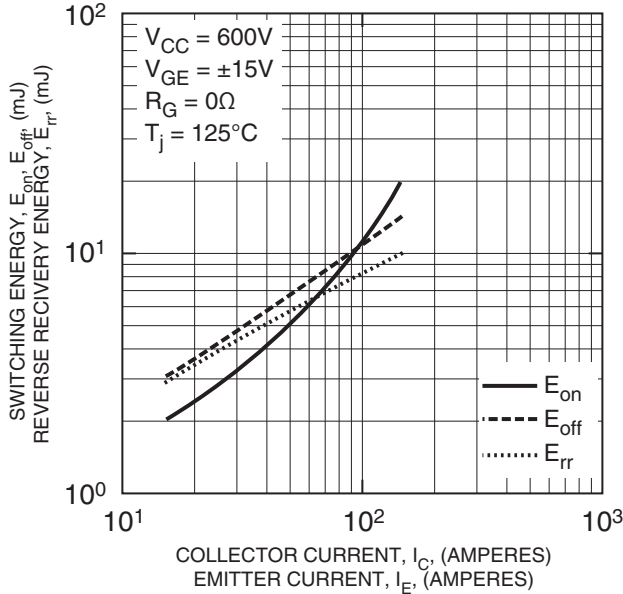

**HALF-BRIDGE SWITCHING CHARACTERISTICS (TYPICAL)**

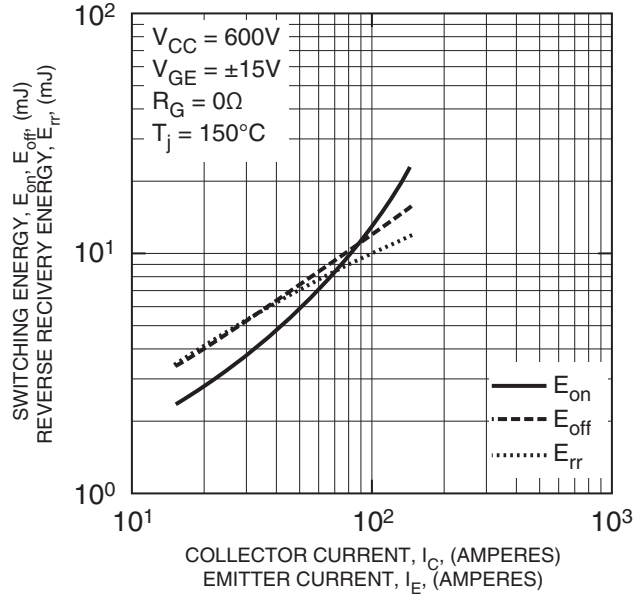

**HALF-BRIDGE SWITCHING CHARACTERISTICS (TYPICAL)**

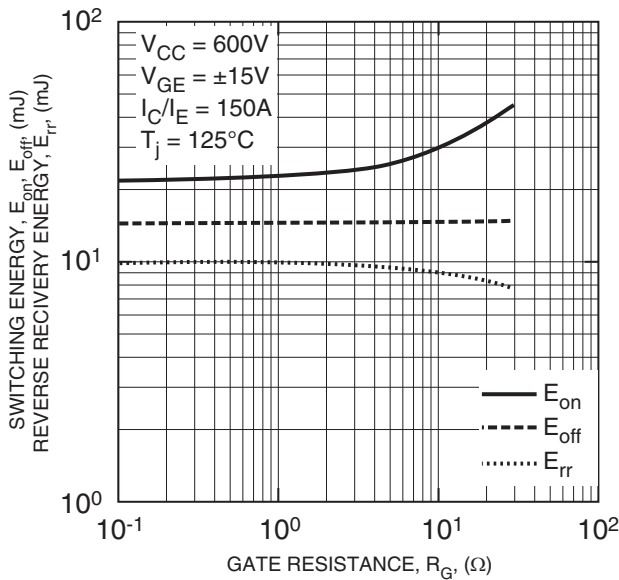

**HALF-BRIDGE SWITCHING CHARACTERISTICS (TYPICAL)**

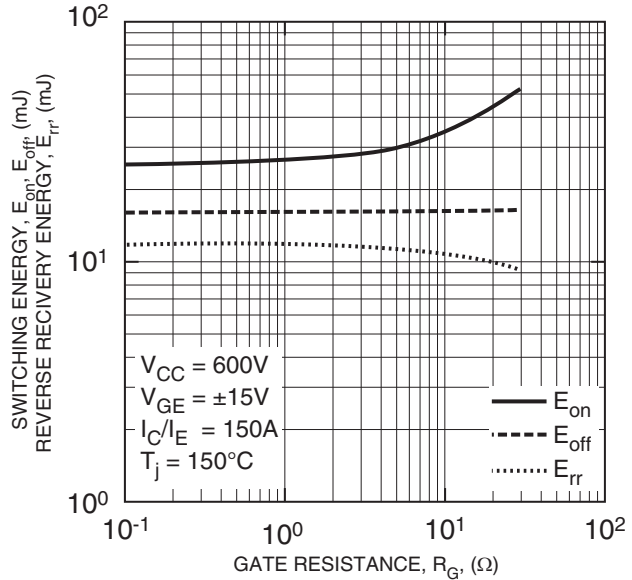



**CM150EXS-24S**  
**Chopper IGBT NX-Series Module**  
 150 Amperes/1200 Volts

