



6-Channel LCD and Camera EMI Filter Array with ESD Protection

CM1499-E6DE

Features

- Six channels of EMI filtering with integrated ESD protection
- Pi-style EMI filters in a capacitor-resistor-capacitor (C-R-C) network
- $\pm 15\text{kV}$ ESD protection on each channel (IEC 61000-4-2 Level 4, contact discharge)
- $\pm 30\text{kV}$ ESD protection on each channel (HBM)
- Greater than -35dB attenuation (typical) at 1GHz
- 12-lead DFN package with 0.50mm lead pitch
- Tiny 3.0mm x 1.35mm DFN package size
- Increased robustness against vertical impacts during manufacturing process
- RoHS compliant, lead-free finishing

Applications

- LCD and Camera data lines in mobile handsets
- I/O port protection for mobile handsets, notebook computers, PDAs etc.
- EMI filtering for data ports in cell phones, PDAs or notebook computers.
- Wireless handsets
- Handheld PCs/PDAs
- LCD and camera modules

Product Description

The CM1499-E6DE is a 6-channel pi-style EMI filter array with ESD protection that integrates six filters (C-R-C) into a small form factor 0.50mm pitch, DFN package. The CM1499-E6DE has component values of 15pF-100 Ω -15pF per channel. The CM1499-E6DE provides a cut-off frequency of 110MHz and can be used in applications with data rates of up to 44Mbps. The parts include ESD diodes on every pin that provide a very high level of protection for sensitive electronic components against possible electrostatic discharge (ESD). The ESD protection diodes safely dissipate ESD strikes of $\pm 15\text{kV}$, which well beyond the maximum requirement of the IEC61000-4-2 international standard. In accordance with MIL-STD-883 (Method 3015) specification for Human Body Model (HBM) ESD, the pins are protected for contact discharges at greater than $\pm 30\text{kV}$.

These devices are particularly well-suited for portable electronics (e.g. wireless handsets, PDAs, notebook computers) because of their small package and easy-to-use pin assignments. In particular, the CM1499-E6DE is ideal for EMI filtering and protecting data and control lines for the I/O data ports, LCD display and camera interface in mobile handsets.

The CM1499-E6DE is housed in a space-saving, low-profile 12-lead DFN package with a 0.50mm pitch with RoHS compliant lead-free finishing.

Electrical Schematic

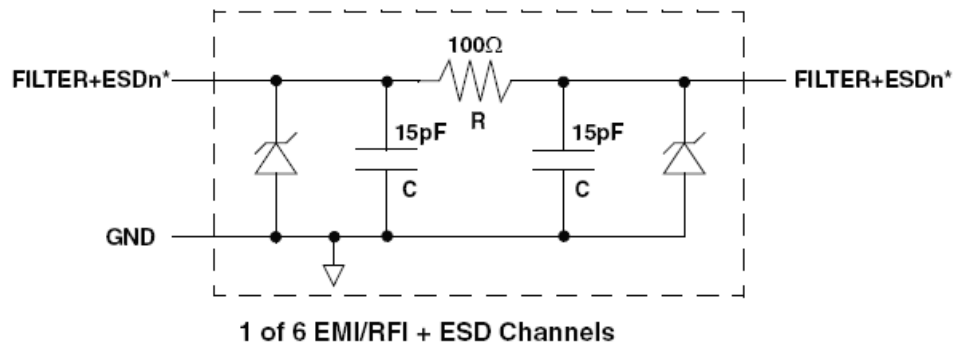

* See Package/Pinout Diagram for expanded pin information.

PACKAGE / PINOUT DIAGRAMS

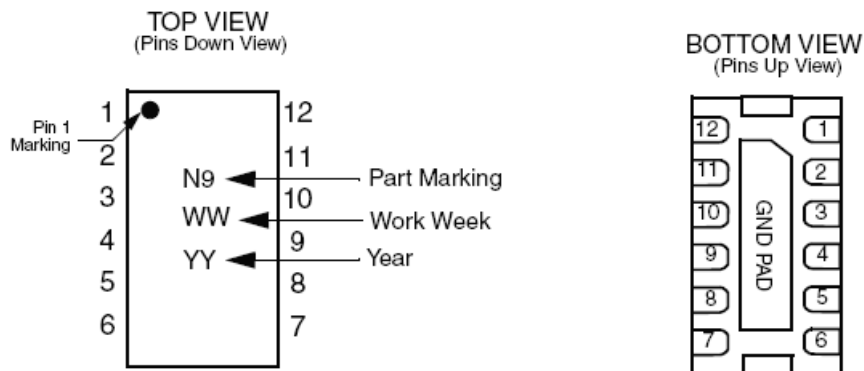

CM1499-E6DE
12 Lead DFN Package

Note:
1) These drawings are not to scale.

PIN DESCRIPTIONS

PINS	NAME	DESCRIPTION	PINS	NAME	DESCRIPTION
1	FILTER1	Filter + ESD Channel 1	12	FILTER1	Filter + ESD Channel 1
2	FILTER2	Filter + ESD Channel 2	11	FILTER2	Filter + ESD Channel 2
3	FILTER3	Filter + ESD Channel 3	10	FILTER3	Filter + ESD Channel 3
4	FILTER4	Filter + ESD Channel 4	9	FILTER4	Filter + ESD Channel 4
5	FILTER5	Filter + ESD Channel 5	8	FILTER5	Filter + ESD Channel 5
6	FILTER6	Filter + ESD Channel 6	7	FILTER6	Filter + ESD Channel 6
GND PAD	GND	Device Ground			

CM1499-E6DE

Ordering Information

PART NUMBERING INFORMATION			
Pins	Package	Lead-free Finish	
		Ordering Part Number ¹	Part Marking
12	DFN-12	CM1499 -E6DE	N9

Note 1: Parts are shipped in Tape & Reel form unless otherwise specified.

Specifications

ABSOLUTE MAXIMUM RATINGS		
PARAMETER	RATING	UNITS
Storage Temperature Range	-65 to +150	°C
DC Power per Resistor	100	mW
DC Package Power Rating	500	mW

STANDARD OPERATING CONDITIONS		
PARAMETER	RATING	UNITS
Operating Temperature Range	-40 to +85	°C

ELECTRICAL OPERATING CHARACTERISTICS (SEE NOTE1)

SYMBOL	PARAMETER	CONDITIONS	MIN	TYP	MAX	UNITS
R	Resistance		85	100	115	Ω
C _{TOTAL}	Total Channel Capacitance	At 2.5VDC Reverse Bias, 1MHz, 30mVAC	24	30	36	pF
C	Capacitance C ₁	At 2.5VDC Reverse Bias, 1MHz, 30mVAC		15		pF
V _{DIODE}	Standoff Voltage	I _{DIODE} =1mA	6.0	7.0	8.0	V
I _{LEAK}	Diode Leakage Current (reverse bias)	V _{DIODE} = +3.0V		0.1	1.0	mA
V _{ESD}	In-system ESD Withstand Voltage a) Human Body Model, MIL-STD-883, Method 3015 b) Contact Discharge per IEC 61000-4-2 Level 4	Note 2	± 30			kV
R _{DYN}	Dynamic Resistance Positive Negative			2.3 0.9		W W
f _C	Cut-off Frequency Z _{SOURCE} =50 Ω , Z _{LOAD} =50 Ω	Channel R = 100 Ω , Channel C = 15pF		110		MHz
A _{1GHz}	Absolute Attenuation @ 1GHz from 0dB Level	Z _{SOURCE} = 50 Ω , Z _{LOAD} = 50 Ω , DC Bias = 0V; Notes 1 and 3		35		dB
A _{800MHz - 6GHz}	Absolute Attenuation @ 800MHz to 6GHz from 0dB Level	Z _{SOURCE} = 50 Ω , Z _{LOAD} = 50 Ω , DC Bias = 0V; Notes 1 and 3		30		dB

Note 1: T_A=25°C unless otherwise specified.

Note 2: ESD applied to input and output pins with respect to GND, one at a time.

Note 3: Attenuation / RF curves characterized by a network analyzer using microprobes.

CM1499-E6DE

Performance Information

Typical EMI Filter Performance ($T_A=25^\circ\text{C}$, DC Bias=0V, 50 Ohm Environment)

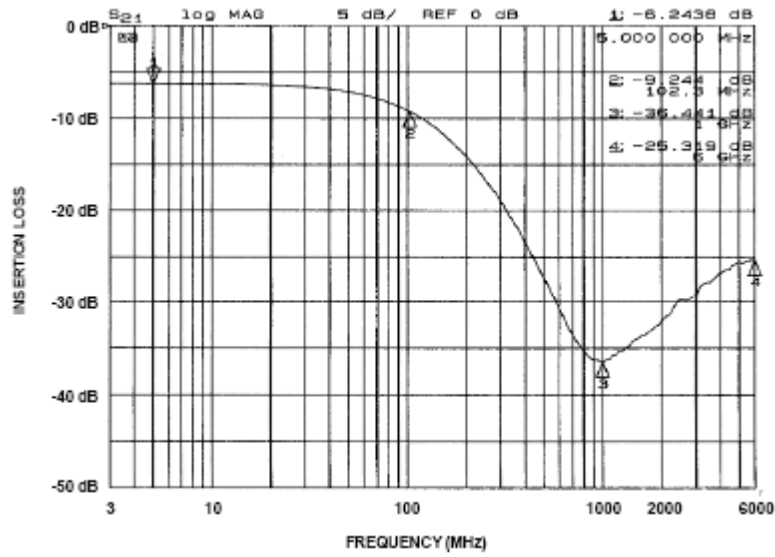

Figure 1. Insertion Loss vs. Frequency (Filter 1 Input to GND)

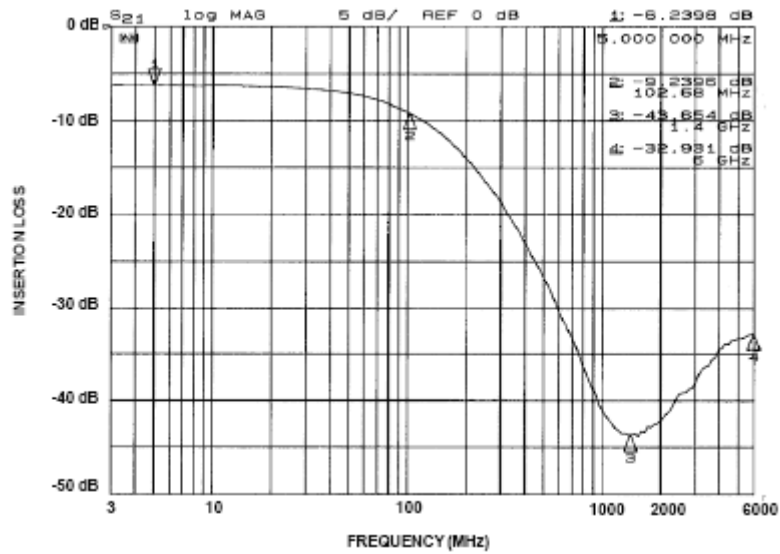

Figure 2. Insertion Loss vs. Frequency (Filter 2 Input to GND)

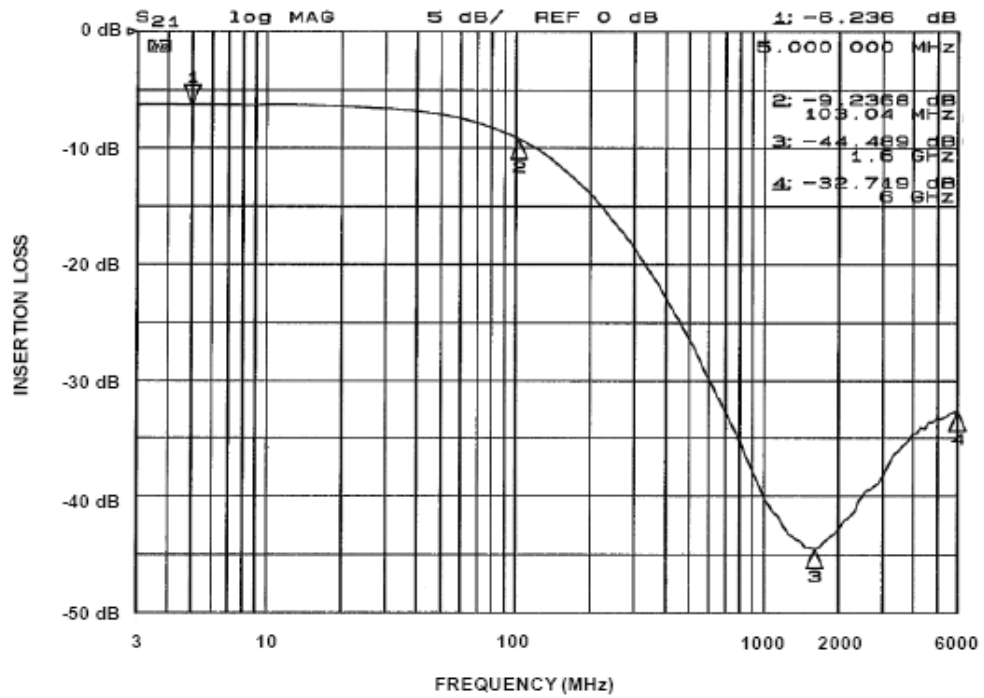

Figure 3. Insertion Loss vs. Frequency (Filter 3 Input to GND)

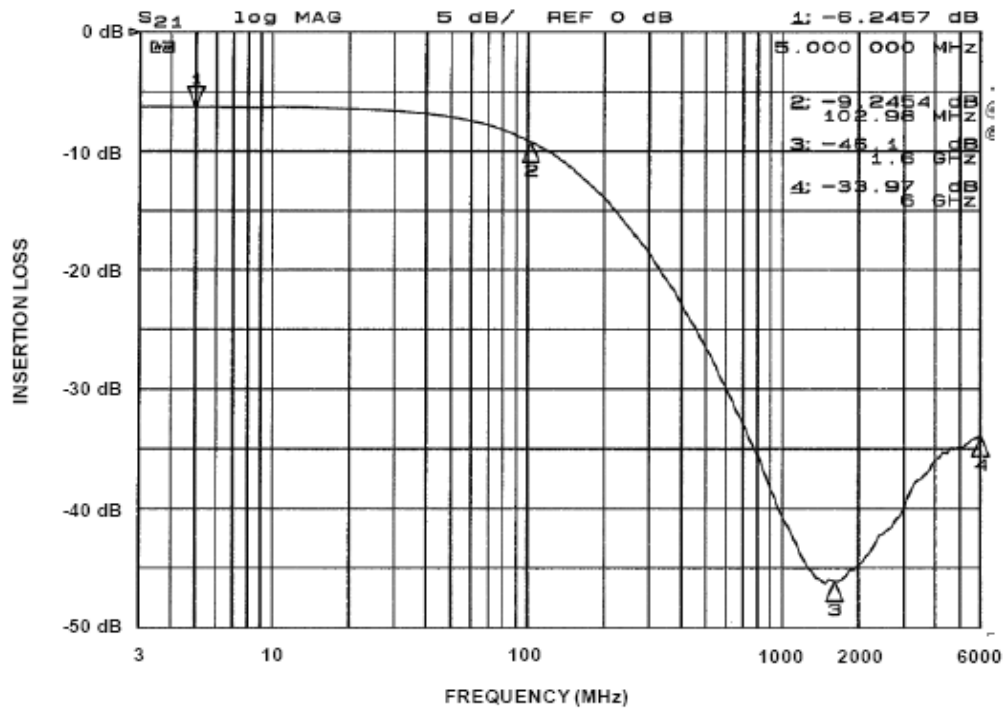

Figure 4. Insertion Loss vs. Frequency (Filter 4 Input to GND)

CM1499-E6DE

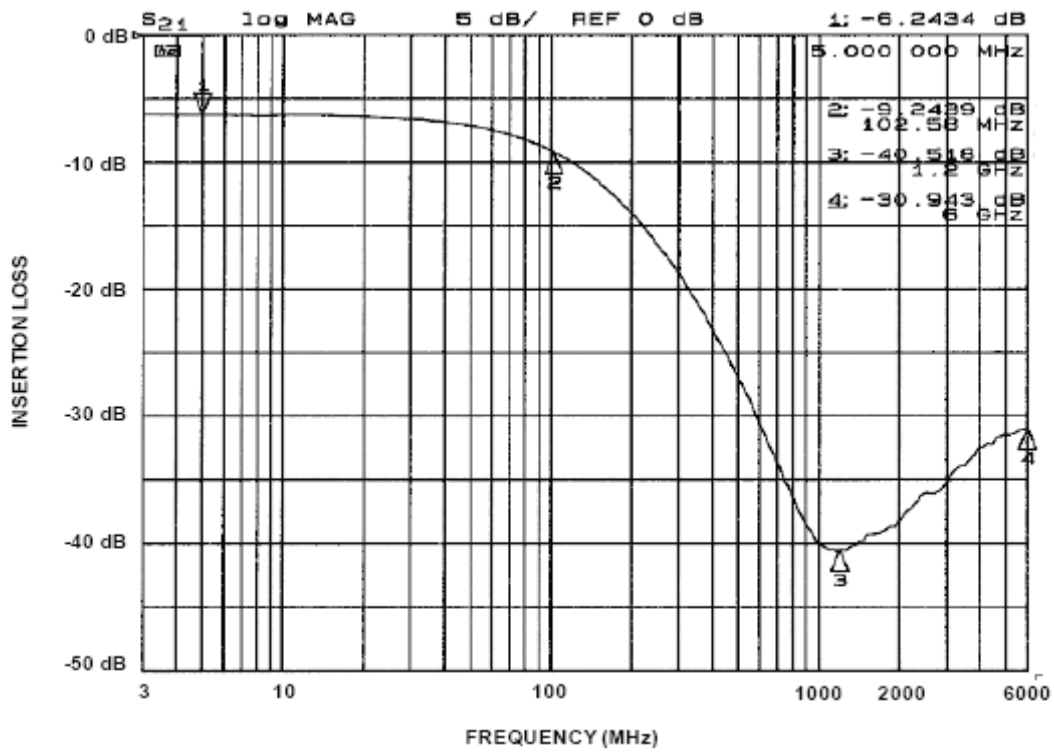

Figure 5. Insertion Loss vs. Frequency (Filter 5 Input to GND)

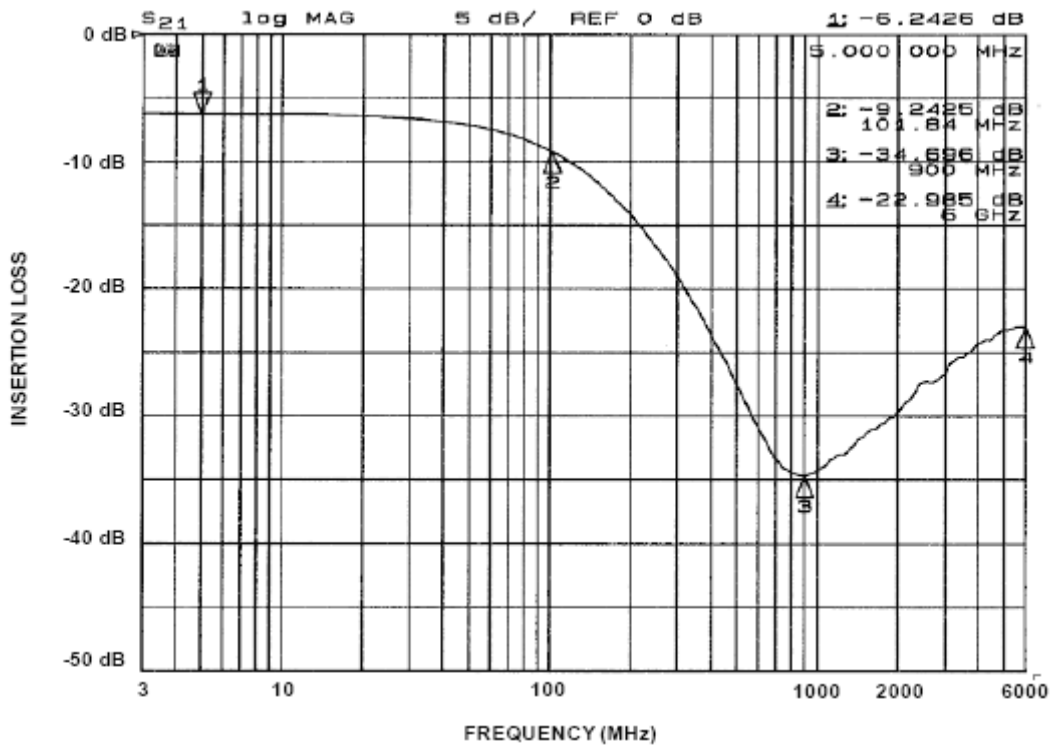
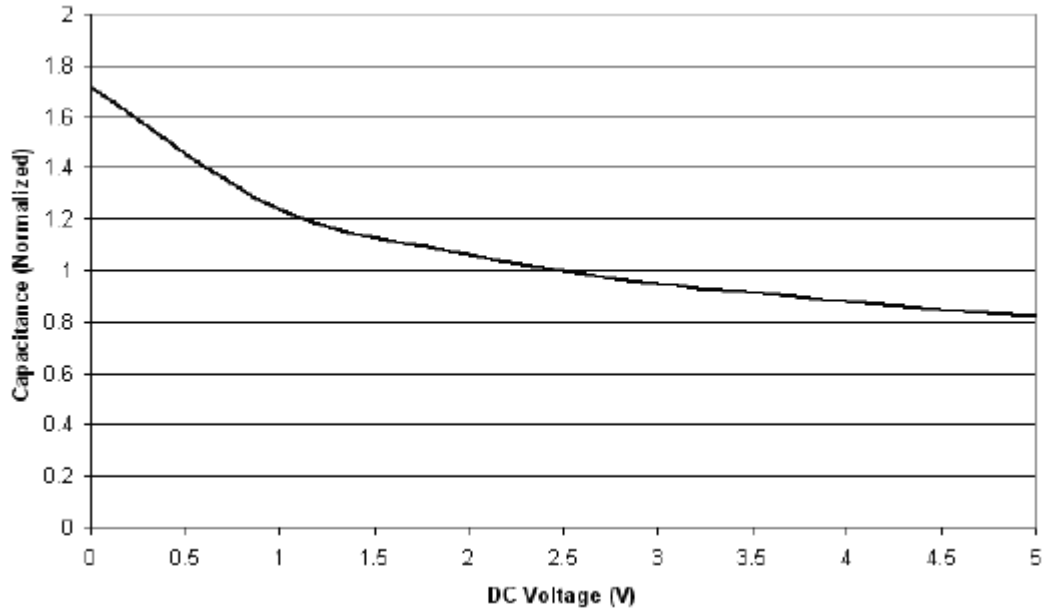

Figure 6. Insertion Loss vs. Frequency (Filter 6 Input to GND)

Performance Information (cont'd)

Typical Diode Capacitance vs. Input Voltage



**Figure 7. Filter Capacitance vs. Input Voltage
(normalized to capacitance at 2.5VDC and 25°C)**

CM1499-E6DE

Mechanical Details

DFN-12 EEP Mechanical Specifications, 0.5mm

The 12-lead, 0.5mm pitch DFN package dimensions with Exposed End Pads (EEP) are presented below.

*This package is compliant with JEDEC standard MO-229C with the exception of the D, D2, E, E2, K and L dimensions as called out in the table above.

PACKAGE DIMENSIONS						
Package	DFN					
JEDEC No.	MO-229C*					
Leads	12					
Dim.	Millimeters			Inches		
	Min	Nom	Max	Min	Nom	Max
A	0.80	0.90	1.00	0.031	0.035	0.039
A1	0.00	0.02	0.05	0.000	0.001	0.002
A3	0.20 REF			0.008 REF		
b	0.20	0.25	0.30	0.008	0.010	0.012
D	2.90	3.00	3.10	0.114	0.118	0.122
D2	2.10	2.20	2.30	0.083	0.087	0.091
E	1.30	1.35	1.40	0.051	0.053	0.055
E2	0.25	0.30	0.35	0.010	0.012	0.014
e	0.50 BSC			0.020 BSC		
F	0.20 REF			0.008 REF		
F1	0.25 REF			0.010 REF		
K	0.28 REF			0.011 REF		
L	0.20	0.25	0.30	0.008	0.010	0.012
# per tape and reel	3000 pieces					
Controlling dimension: millimeters						

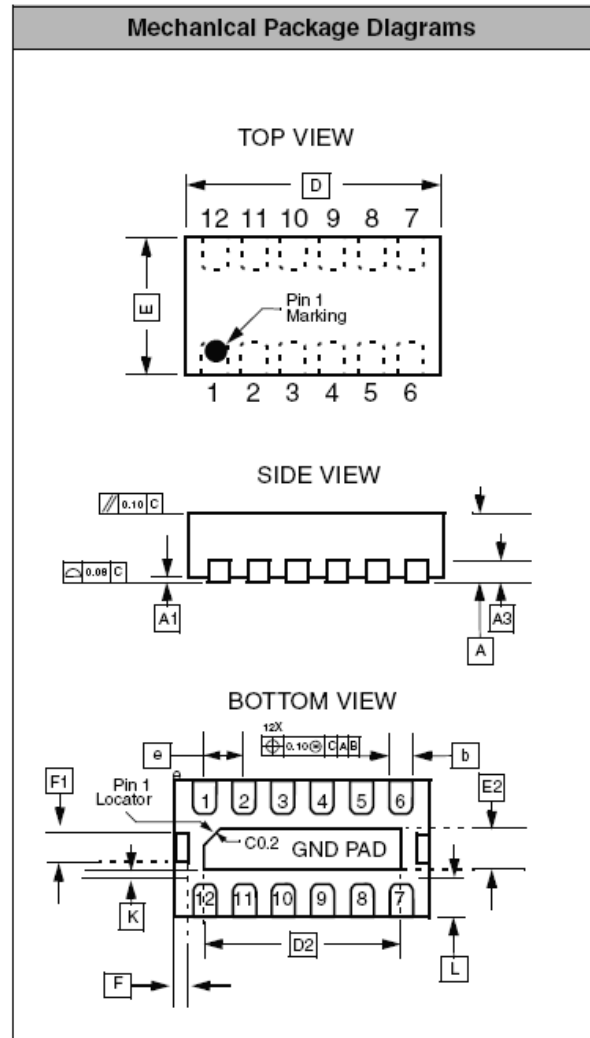

Dimensions for 12-Lead, 0.5mm pitch DFN package with Exposed End Pads (EEP)

Tape and Reel Specifications

PART NUMBER	PACKAGE SIZE (mm)	POCKET SIZE (mm) $B_0 \times A_0 \times K_0$	TAPE WIDTH W	REEL DIAMETER	QTY PER REEL	P_0	P_1
CM1499 -E6DE	1.35 X 3.00 X 0.90	1.60 X 3.35 X 1.10	8mm	178mm (7")	3000	4mm	4mm

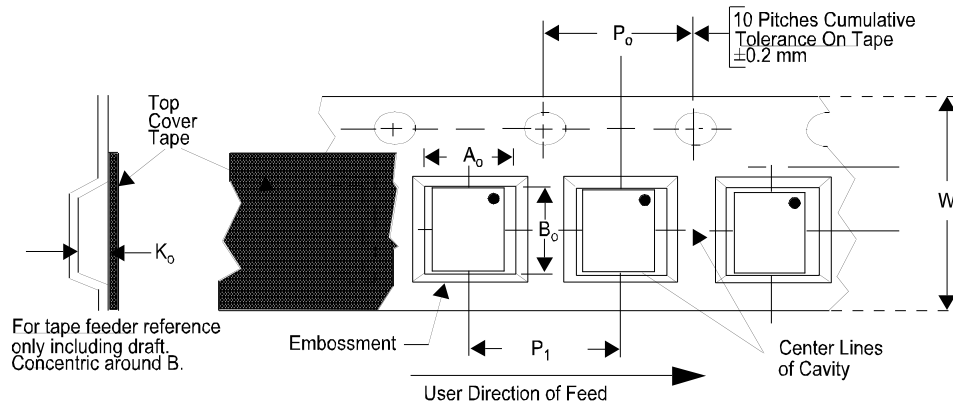

ON Semiconductor and  are registered trademarks of Semiconductor Components Industries, LLC (SCILLC). SCILLC reserves the right to make changes without further notice to any products herein. SCILLC makes no warranty, representation or guarantee regarding the suitability of its products for any particular purpose, nor does SCILLC assume any liability arising out of the application or use of any product or circuit, and specifically disclaims any and all liability, including without limitation special, consequential or incidental damages. "Typical" parameters which may be provided in SCILLC data sheets and/or specifications can and do vary in different applications and actual performance may vary over time. All operating parameters, including "Typicals" must be validated for each customer application by customer's technical experts. SCILLC does not convey any license under its patent rights nor the rights of others. SCILLC products are not designed, intended, or authorized for use as components in systems intended for surgical implant into the body, or other applications intended to support or sustain life, or for any other application in which the failure of the SCILLC product could create a situation where personal injury or death may occur. Should Buyer purchase or use SCILLC products for any such unintended or unauthorized application, Buyer shall indemnify and hold SCILLC and its officers, employees, subsidiaries, affiliates, and distributors harmless against all claims, costs, damages, and expenses, and reasonable attorney fees arising out of, directly or indirectly, any claim of personal injury or death associated with such unintended or unauthorized use, even if such claim alleges that SCILLC was negligent regarding the design or manufacture of the part. SCILLC is an Equal Opportunity/Affirmative Action Employer. This literature is subject to all applicable copyright laws and is not for resale in any manner.

PUBLICATION ORDERING INFORMATION

LITERATURE FULFILLMENT:
Literature Distribution Center for ON Semiconductor
P.O. Box 5163, Denver, Colorado 80217 USA
Phone: 303-675-2175 or 800-344-3860 Toll Free USA/Canada
Fax: 303-675-2176 or 800-344-3867 Toll Free USA/Canada
Email: orderlit@onsemi.com

N. American Technical Support: 800-282-9855
Toll Free USA/Canada
Europe, Middle East and Africa Technical Support:
Phone: 421 33 790 2910
Japan Customer Focus Center
Phone: 81-3-5773-3850

ON Semiconductor Website: www.onsemi.com

Order Literature: <http://www.onsemi.com/orderlit>

For additional information, please contact your local Sales Representative